

X-LSM-E Series Datasheet

Applies to devices sold prior October 2021



- 25, 50, 100, 150, 200 mm travel
- Up to 104 mm/s speed and up to 55 N thrust
- 10 kg load capacity
- Built-in controller; daisy-chains with other Zaber products
- Integrated, 200 CPR, motor mounted encoder provides slip/stall detection and recovery
- Custom versions available

X-LSM-E Series Overview

Zaber's X-LSM-E Series devices are computer-controlled, motorized linear stages with high thrust and speed capabilities and a compact size. They are stand-alone units requiring only a standard 24 V or 48 V power supply. The built-in motor encoder allows closed-loop operation and slip/stall recovery features. An optional indexed knob provides convenient manual control for versatile operation even without a computer.

These stages connect to the RS-232 port or USB port of any computer, and they can be daisy-chained with any other Zaber products. The daisy-chain also shares power, making it possible for multiple X-Series products to share a single power supply. Convenient locking, 4-pin, M8

connectors on the unit allow for secure connection between units.

At only 21 mm high, these miniature stages are excellent for applications where a small profile is required. The X-LSM-E's innovative design allows speeds up to 104 mm/s and loads up to 10 kg. Like all of Zaber's products, the X-LSM-E Series is designed to be 'plug and play' and very easy to set up and operate. If you are considering a multi-axis system, in the XY configuration, these stages make excellent microscope stages. Adding an X-JOY3 joystick controller allows manual control of both X and Y or XYZ axes from a single interface as well as allowing microscope stage positions to be saved and recalled at the touch of a button.

X-LSM-E Series Drawings

ZABER

X-LSM-E Miniature Motorized Linear Stage
dimensions in mm

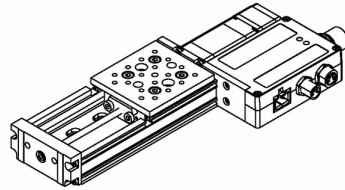

Model Number*	Travel	A**	B
X-LSM025-E	25.4	162.6	75.8
X-LSM050-E	50.8	188.0	101.2
X-LSM100-E	101.6	238.8	152.0
X-LSM150-E	152.4	289.6	202.8
X-LSM200-E	203.2	340.4	253.6

*See product page for complete list of available models at www.zaber.com

**Subtract 13.1 mm knob length from 'A' for -S versions without manual control

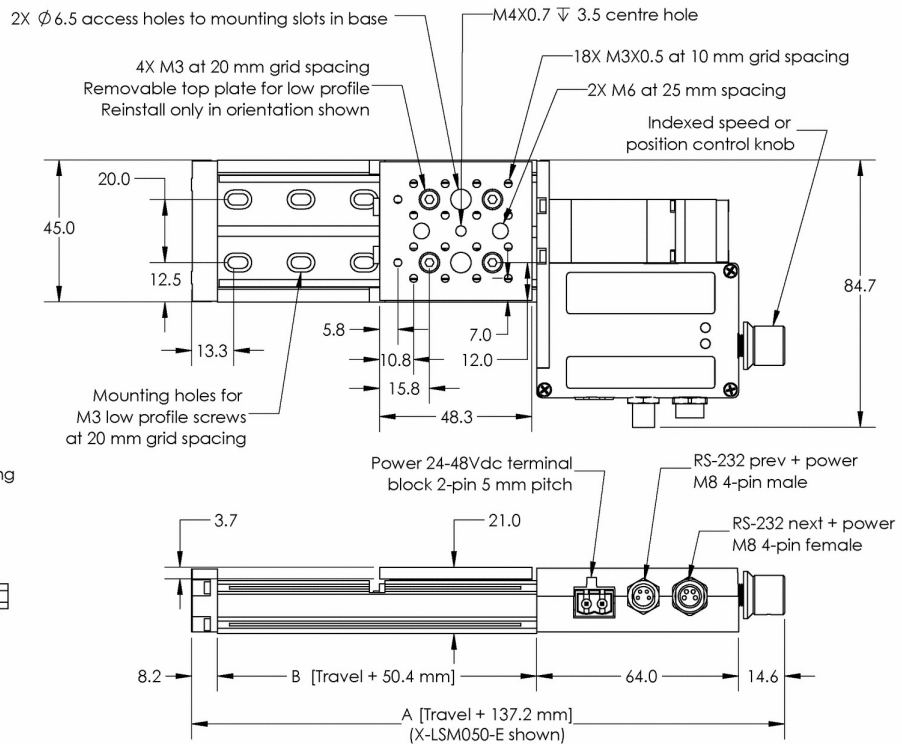

DWG 1080 802

X-LSM-E Series Specifications

Specification	Value	Alternate Unit
Built-in Controller	Yes	
Encoder Resolution	200 CPR	800 states/rev
Encoder Type	Rotary quadrature encoder	
Maximum Continuous Thrust	25 N	5.6 lb
Communication Interface	RS-232	
Communication Protocol	Zaber ASCII (Default), Zaber Binary	
Maximum Centered Load	100 N	22.4 lb
Maximum Cantilever Load	300 N-cm	424.8 oz-in
Guide Type	Needle roller bearing	
Stiffness in Pitch	55 N-m/°	317 µrad/N-m
Stiffness in Roll	52.5 N-m/°	332 µrad/N-m
Stiffness in Yaw	85 N-m/°	205 µrad/N-m
Maximum Current Draw	350 mA	
Power Supply	24-48 VDC	
Power Plug	2-pin Screw Terminal	
Motor Steps Per Rev	200	
Motor Type	Stepper (2 phase)	
Motor Rated Current	600 mA/phase	
Inductance	3.5 mH/phase	
Default Resolution	1/64 of a step	
Data Cable Connection	Locking 4-pin M8	
Mechanical Drive System	Precision lead screw	
Limit or Home Sensing	Magnetic hall sensor	
Axes of Motion	1	
LED Indicators	Yes	
Mounting Interface	M3 and M6 threaded holes and M4 threaded centre hole	
Operating Temperature Range	0 to 50 °C	
Vacuum Compatible	No	
RoHS Compliant	Yes	
Stage Parallelism	< 25 µm	< 0.000984"

Specification	Value	Alternate Unit
CE Compliant	Yes	

Part Number	Microstep Size (Default Resolution)	Travel Range	Accuracy (unidirectional)	Repeatability
X-LSM025A-E03	0.047625 μm	25.4 mm (1.000")	15 μm (0.000591")	< 3 μm (< 0.000118")
X-LSM025A-SE03	0.047625 μm	25.4 mm (1.000")	15 μm (0.000591")	< 3 μm (< 0.000118")
X-LSM025B-E03	0.1905 μm	25.4 mm (1.000")	15 μm (0.000591")	< 6 μm (< 0.000236")
X-LSM025B-SE03	0.1905 μm	25.4 mm (1.000")	15 μm (0.000591")	< 6 μm (< 0.000236")
X-LSM050A-E03	0.047625 μm	50.8 mm (2.000")	20 μm (0.000787")	< 3 μm (< 0.000118")
X-LSM050A-SE03	0.047625 μm	50.8 mm (2.000")	20 μm (0.000787")	< 3 μm (< 0.000118")
X-LSM050B-E03	0.1905 μm	50.8 mm (2.000")	25 μm (0.000984")	< 6 μm (< 0.000236")
X-LSM050B-SE03	0.1905 μm	50.8 mm (2.000")	25 μm (0.000984")	< 6 μm (< 0.000236")
X-LSM100A-E03	0.047625 μm	101.6 mm (4.000")	35 μm (0.001378")	< 3 μm (< 0.000118")
X-LSM100A-SE03	0.047625 μm	101.6 mm (4.000")	35 μm (0.001378")	< 3 μm (< 0.000118")
X-LSM100B-E03	0.1905 μm	101.6 mm (4.000")	45 μm (0.001772")	< 6 μm (< 0.000236")
X-LSM100B-SE03	0.1905 μm	101.6 mm (4.000")	45 μm (0.001772")	< 6 μm (< 0.000236")
X-LSM150A-E03	0.047625 μm	152.4 mm (6.000")	50 μm (0.001968")	< 3 μm (< 0.000118")
X-LSM150A-SE03	0.047625 μm	152.4 mm (6.000")	50 μm (0.001968")	< 3 μm (< 0.000118")
X-LSM150B-E03	0.1905 μm	152.4 mm (6.000")	65 μm (0.002559")	< 6 μm (< 0.000236")
X-LSM150B-SE03	0.1905 μm	152.4 mm (6.000")	65 μm (0.002559")	< 6 μm (< 0.000236")
X-LSM200A-E03	0.047625 μm	203.2 mm (8.000")	60 μm (0.002362")	< 3 μm (< 0.000118")
X-LSM200A-SE03	0.047625 μm	203.2 mm (8.000")	60 μm (0.002362")	< 3 μm (< 0.000118")
X-LSM200B-E03	0.1905 μm	203.2 mm	85 μm	< 6 μm

Part Number	Microstep Size (Default Resolution)	Travel Range	Accuracy (unidirectional)	Repeatability
		(8.000")	(0.003346")	(< 0.000236")

X-LSM200B-SE03	0.1905 µm	203.2 mm (8.000")	85 µm (0.003346")	< 6 µm (< 0.000236")
----------------	-----------	----------------------	----------------------	-------------------------

Part Number	Backlash	Maximum Speed	Minimum Speed	Speed Resolution
-------------	----------	---------------	---------------	------------------

X-LSM025A-E03	< 12 µm (< 0.000472")	26 mm/s (1.024"/s)	0.000029 mm/s (0.000001"/s)	0.000029 mm/s (0.000001"/s)
---------------	--------------------------	-----------------------	--------------------------------	--------------------------------

X-LSM025A-SE03	< 12 µm (< 0.000472")	26 mm/s (1.024"/s)	0.000029 mm/s (0.000001"/s)	0.000029 mm/s (0.000001"/s)
----------------	--------------------------	-----------------------	--------------------------------	--------------------------------

X-LSM025B-E03	< 16 µm (< 0.000630")	104 mm/s (4.094"/s)	0.000116 mm/s (0.000005"/s)	0.000116 mm/s (0.000005"/s)
---------------	--------------------------	------------------------	--------------------------------	--------------------------------

X-LSM025B-SE03	< 16 µm (< 0.000630")	104 mm/s (4.094"/s)	0.000116 mm/s (0.000005"/s)	0.000116 mm/s (0.000005"/s)
----------------	--------------------------	------------------------	--------------------------------	--------------------------------

X-LSM050A-E03	< 12 µm (< 0.000472")	26 mm/s (1.024"/s)	0.000029 mm/s (0.000001"/s)	0.000029 mm/s (0.000001"/s)
---------------	--------------------------	-----------------------	--------------------------------	--------------------------------

X-LSM050A-SE03	< 12 µm (< 0.000472")	26 mm/s (1.024"/s)	0.000029 mm/s (0.000001"/s)	0.000029 mm/s (0.000001"/s)
----------------	--------------------------	-----------------------	--------------------------------	--------------------------------

X-LSM050B-E03	< 16 µm (< 0.000630")	104 mm/s (4.094"/s)	0.000116 mm/s (0.000005"/s)	0.000116 mm/s (0.000005"/s)
---------------	--------------------------	------------------------	--------------------------------	--------------------------------

X-LSM050B-SE03	< 16 µm (< 0.000630")	104 mm/s (4.094"/s)	0.000116 mm/s (0.000005"/s)	0.000116 mm/s (0.000005"/s)
----------------	--------------------------	------------------------	--------------------------------	--------------------------------

X-LSM100A-E03	< 12 µm (< 0.000472")	26 mm/s (1.024"/s)	0.000029 mm/s (0.000001"/s)	0.000029 mm/s (0.000001"/s)
---------------	--------------------------	-----------------------	--------------------------------	--------------------------------

X-LSM100A-SE03	< 12 µm (< 0.000472")	26 mm/s (1.024"/s)	0.000029 mm/s (0.000001"/s)	0.000029 mm/s (0.000001"/s)
----------------	--------------------------	-----------------------	--------------------------------	--------------------------------

X-LSM100B-E03	< 16 µm (< 0.000630")	104 mm/s (4.094"/s)	0.000116 mm/s (0.000005"/s)	0.000116 mm/s (0.000005"/s)
---------------	--------------------------	------------------------	--------------------------------	--------------------------------

X-LSM100B-SE03	< 16 µm (< 0.000630")	104 mm/s (4.094"/s)	0.000116 mm/s (0.000005"/s)	0.000116 mm/s (0.000005"/s)
----------------	--------------------------	------------------------	--------------------------------	--------------------------------

X-LSM150A-E03	< 12 µm (< 0.000472")	26 mm/s (1.024"/s)	0.000029 mm/s (0.000001"/s)	0.000029 mm/s (0.000001"/s)
---------------	--------------------------	-----------------------	--------------------------------	--------------------------------

X-LSM150A-SE03	< 12 µm (< 0.000472")	26 mm/s (1.024"/s)	0.000029 mm/s (0.000001"/s)	0.000029 mm/s (0.000001"/s)
----------------	--------------------------	-----------------------	--------------------------------	--------------------------------

X-LSM150B-E03	< 16 µm (< 0.000630")	104 mm/s (4.094"/s)	0.000116 mm/s (0.000005"/s)	0.000116 mm/s (0.000005"/s)
---------------	--------------------------	------------------------	--------------------------------	--------------------------------

X-LSM150B-SE03	< 16 µm (< 0.000630")	104 mm/s (4.094"/s)	0.000116 mm/s (0.000005"/s)	0.000116 mm/s (0.000005"/s)
----------------	--------------------------	------------------------	--------------------------------	--------------------------------

X-LSM200A-E03	< 12 µm (< 0.000472")	26 mm/s (1.024"/s)	0.000029 mm/s (0.000001"/s)	0.000029 mm/s (0.000001"/s)
---------------	--------------------------	-----------------------	--------------------------------	--------------------------------

Part Number	Backlash	Maximum Speed	Minimum Speed	Speed Resolution
X-LSM200A-SE03	< 12 μm (< 0.000472")	26 mm/s (1.024"/s)	0.000029 mm/s (0.000001"/s)	0.000029 mm/s (0.000001"/s)
X-LSM200B-E03	< 16 μm (< 0.000630")	104 mm/s (4.094"/s)	0.000116 mm/s (0.000005"/s)	0.000116 mm/s (0.000005"/s)
X-LSM200B-SE03	< 16 μm (< 0.000630")	104 mm/s (4.094"/s)	0.000116 mm/s (0.000005"/s)	0.000116 mm/s (0.000005"/s)

Part Number	Peak Thrust	Vertical Runout	Horizontal Runout	Pitch
X-LSM025A-E03	55 N (12.3 lb)	< 8 μm (< 0.000315")	< 12 μm (< 0.000472")	0.02° (0.349 mrad)
X-LSM025A-SE03	55 N (12.3 lb)	< 8 μm (< 0.000315")	< 12 μm (< 0.000472")	0.02° (0.349 mrad)
X-LSM025B-E03	25 N (5.6 lb)	< 8 μm (< 0.000315")	< 12 μm (< 0.000472")	0.02° (0.349 mrad)
X-LSM025B-SE03	25 N (5.6 lb)	< 8 μm (< 0.000315")	< 12 μm (< 0.000472")	0.02° (0.349 mrad)
X-LSM050A-E03	55 N (12.3 lb)	< 11 μm (< 0.000433")	< 14 μm (< 0.000551")	0.03° (0.523 mrad)
X-LSM050A-SE03	55 N (12.3 lb)	< 11 μm (< 0.000433")	< 14 μm (< 0.000551")	0.03° (0.523 mrad)
X-LSM050B-E03	25 N (5.6 lb)	< 11 μm (< 0.000433")	< 14 μm (< 0.000551")	0.03° (0.523 mrad)
X-LSM050B-SE03	25 N (5.6 lb)	< 11 μm (< 0.000433")	< 14 μm (< 0.000551")	0.03° (0.523 mrad)
X-LSM100A-E03	55 N (12.3 lb)	< 18 μm (< 0.000709")	< 18 μm (< 0.000709")	0.04° (0.698 mrad)
X-LSM100A-SE03	55 N (12.3 lb)	< 18 μm (< 0.000709")	< 18 μm (< 0.000709")	0.04° (0.698 mrad)
X-LSM100B-E03	25 N (5.6 lb)	< 18 μm (< 0.000709")	< 18 μm (< 0.000709")	0.04° (0.698 mrad)
X-LSM100B-SE03	25 N (5.6 lb)	< 18 μm (< 0.000709")	< 18 μm (< 0.000709")	0.04° (0.698 mrad)
X-LSM150A-E03	55 N (12.3 lb)	< 25 μm (< 0.000984")	< 23 μm (< 0.000906")	0.04° (0.698 mrad)
X-LSM150A-SE03	55 N (12.3 lb)	< 25 μm (< 0.000984")	< 23 μm (< 0.000906")	0.04° (0.698 mrad)
X-LSM150B-E03	25 N (5.6 lb)	< 25 μm (< 0.000984")	< 23 μm (< 0.000906")	0.04° (0.698 mrad)
X-LSM150B-SE03	25 N (5.6 lb)	< 25 μm (< 0.000984")	< 23 μm (< 0.000906")	0.04° (0.698 mrad)

Part Number	Peak Thrust	Vertical Runout	Horizontal Runout	Pitch
X-LSM200A-E03	55 N (12.3 lb)	< 32 μ m (< 0.001260")	< 27 μ m (< 0.001063")	0.04° (0.698 mrad)
X-LSM200A-SE03	55 N (12.3 lb)	< 32 μ m (< 0.001260")	< 27 μ m (< 0.001063")	0.04° (0.698 mrad)
X-LSM200B-E03	25 N (5.6 lb)	< 32 μ m (< 0.001260")	< 27 μ m (< 0.001063")	0.04° (0.698 mrad)
X-LSM200B-SE03	25 N (5.6 lb)	< 32 μ m (< 0.001260")	< 27 μ m (< 0.001063")	0.04° (0.698 mrad)

Part Number	Roll	Yaw	Linear Motion Per Motor Rev	Manual Control
X-LSM025A-E03	0.02° (0.349 mrad)	0.03° (0.523 mrad)	0.6096 mm (0.024")	Yes
X-LSM025A-SE03	0.02° (0.349 mrad)	0.03° (0.523 mrad)	0.6096 mm (0.024")	No
X-LSM025B-E03	0.02° (0.349 mrad)	0.03° (0.523 mrad)	2.4384 mm (0.096")	Yes
X-LSM025B-SE03	0.02° (0.349 mrad)	0.03° (0.523 mrad)	2.4384 mm (0.096")	No
X-LSM050A-E03	0.03° (0.523 mrad)	0.03° (0.523 mrad)	0.6096 mm (0.024")	Yes
X-LSM050A-SE03	0.03° (0.523 mrad)	0.03° (0.523 mrad)	0.6096 mm (0.024")	No
X-LSM050B-E03	0.03° (0.523 mrad)	0.03° (0.523 mrad)	2.4384 mm (0.096")	Yes
X-LSM050B-SE03	0.03° (0.523 mrad)	0.03° (0.523 mrad)	2.4384 mm (0.096")	No
X-LSM100A-E03	0.04° (0.698 mrad)	0.04° (0.698 mrad)	0.6096 mm (0.024")	Yes
X-LSM100A-SE03	0.04° (0.698 mrad)	0.04° (0.698 mrad)	0.6096 mm (0.024")	No
X-LSM100B-E03	0.04° (0.698 mrad)	0.04° (0.698 mrad)	2.4384 mm (0.096")	Yes
X-LSM100B-SE03	0.04° (0.698 mrad)	0.04° (0.698 mrad)	2.4384 mm (0.096")	No
X-LSM150A-E03	0.05° (0.873 mrad)	0.05° (0.873 mrad)	0.6096 mm (0.024")	Yes
X-LSM150A-SE03	0.05° (0.873 mrad)	0.05° (0.873 mrad)	0.6096 mm (0.024")	No
X-LSM150B-E03	0.05° (0.873 mrad)	0.05° (0.873 mrad)	2.4384 mm (0.096")	Yes

Part Number	Roll	Yaw	Linear Motion Per Motor Rev	Manual Control
X-LSM150B-SE03	0.05° (0.873 mrad)	0.05° (0.873 mrad)	2.4384 mm (0.096")	No
X-LSM200A-E03	0.05° (0.873 mrad)	0.05° (0.873 mrad)	0.6096 mm (0.024")	Yes
X-LSM200A-SE03	0.05° (0.873 mrad)	0.05° (0.873 mrad)	0.6096 mm (0.024")	No
X-LSM200B-E03	0.05° (0.873 mrad)	0.05° (0.873 mrad)	2.4384 mm (0.096")	Yes
X-LSM200B-SE03	0.05° (0.873 mrad)	0.05° (0.873 mrad)	2.4384 mm (0.096")	No

Part Number	Weight
X-LSM025A-E03	0.35 kg (0.772 lb)
X-LSM025A-SE03	0.35 kg (0.772 lb)
X-LSM025B-E03	0.35 kg (0.772 lb)
X-LSM025B-SE03	0.35 kg (0.772 lb)
X-LSM050A-E03	0.36 kg (0.794 lb)
X-LSM050A-SE03	0.36 kg (0.794 lb)
X-LSM050B-E03	0.36 kg (0.794 lb)
X-LSM050B-SE03	0.36 kg (0.794 lb)
X-LSM100A-E03	0.39 kg (0.860 lb)
X-LSM100A-SE03	0.39 kg (0.860 lb)
X-LSM100B-E03	0.39 kg (0.860 lb)
X-LSM100B-SE03	0.39 kg (0.860 lb)
X-LSM150A-E03	0.43 kg (0.948 lb)
X-LSM150A-SE03	0.43 kg (0.948 lb)
X-LSM150B-E03	0.43 kg (0.948 lb)
X-LSM150B-SE03	0.43 kg (0.948 lb)
X-LSM200A-E03	0.46 kg (1.014 lb)
X-LSM200A-SE03	0.46 kg (1.014 lb)
X-LSM200B-E03	0.46 kg (1.014 lb)
X-LSM200B-SE03	0.46 kg (1.014 lb)

X-LSM-E Series Charts

Thrust Speed Performance

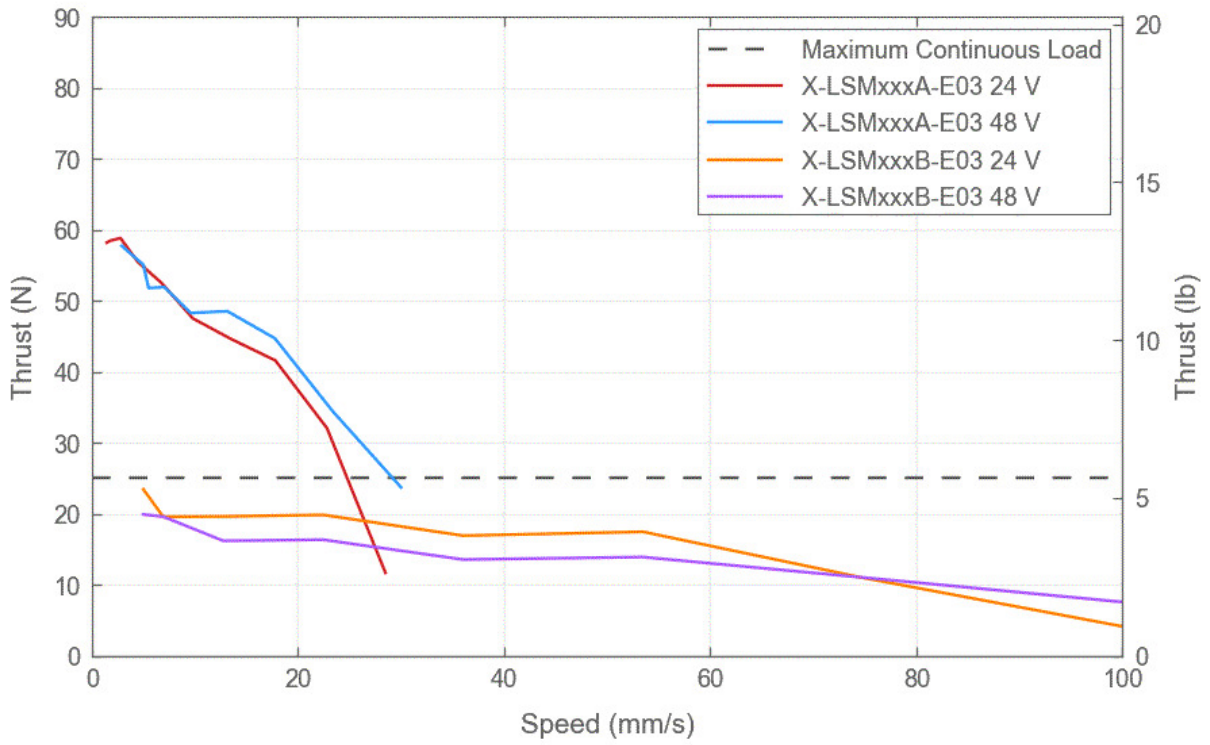

LSM Linear Bearing Lifetime

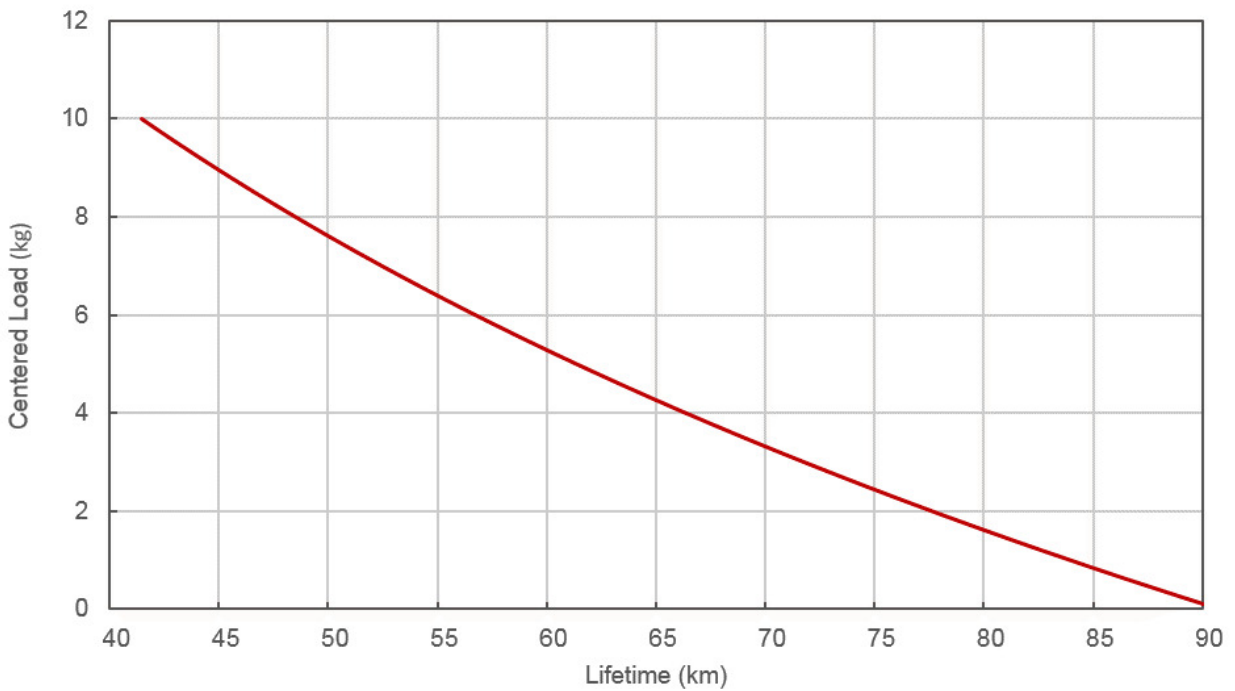

Typical Accuracy

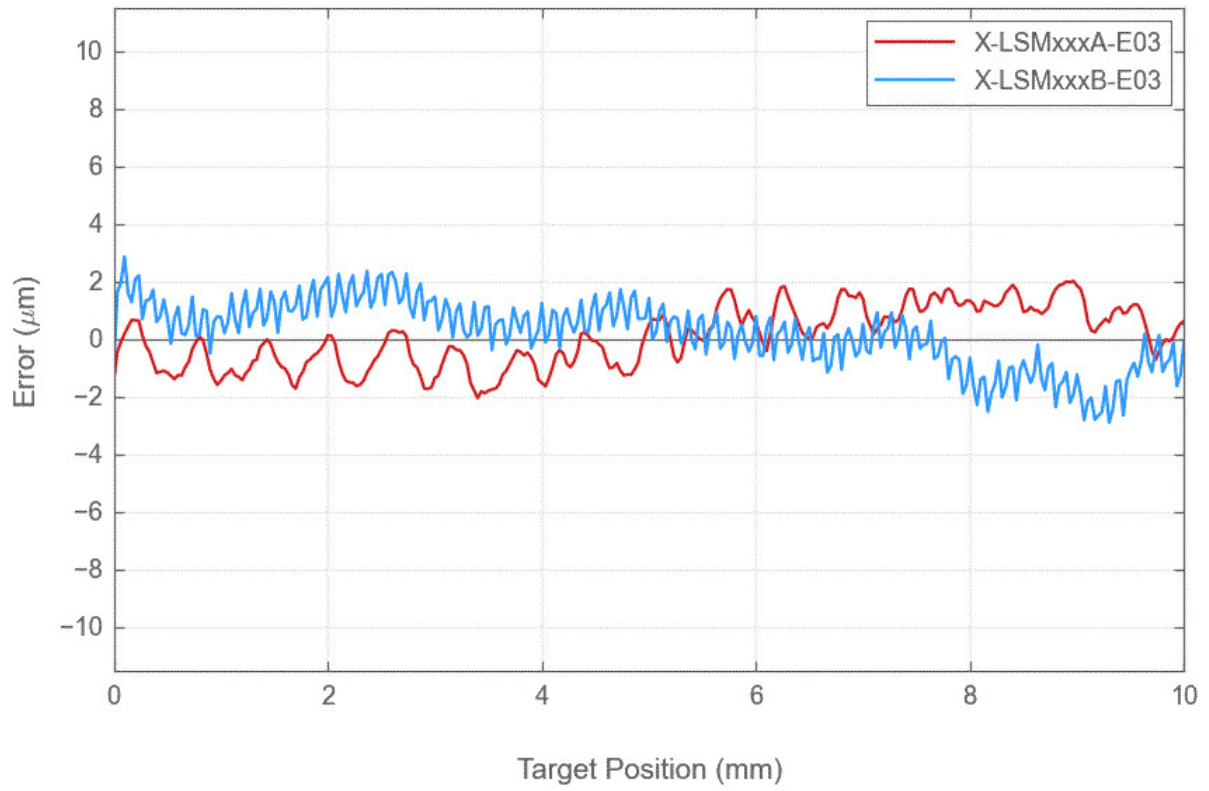

Typical Microstepping Accuracy

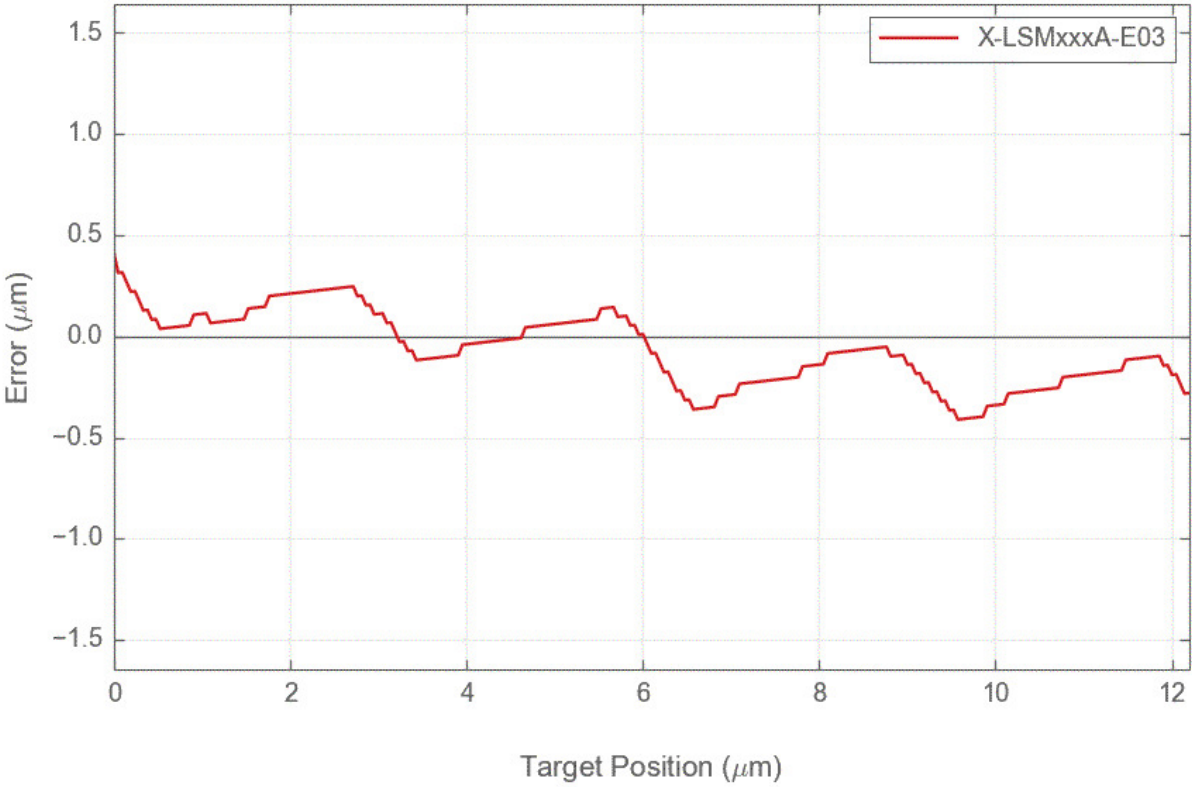

Typical Microstepping Accuracy

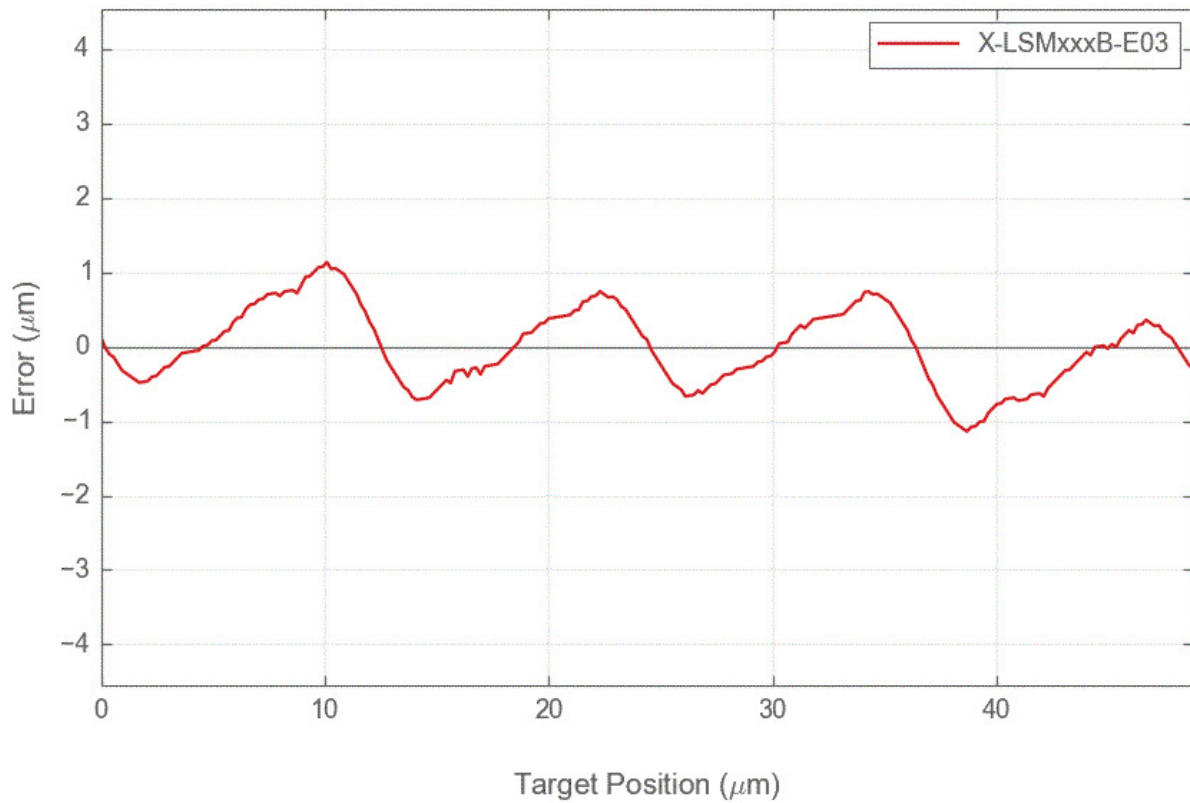

Contact

Email: contact@zaber.com

Phone (toll free Canada/USA): 1-888-276-8033

Phone (direct): 1-604-569-3780

Fax: 1-604-648-8033

Zaber Technologies Inc.

#2 - 605 West Kent Ave. N.

Vancouver, British Columbia

Canada, V6P 6T7

<https://www.zaber.com>