

X-LSM150A-E03 Datasheet



- 25, 50, 100, 150, 200 mm travel
- Up to 104 mm/s speed and up to 55 N thrust
- Recirculating ball bearing design for high load (25 kg) and long lifetime
- Built-in controller; daisy-chains with other Zaber products
- Integrated, 200 CPR, motor mounted encoder provides slip/stall detection and recovery
- Custom versions available

X-LSM-E Series Overview

Zaber's X-LSM-E Series devices are computer-controlled, motorized linear stages with high thrust and speed capabilities and a compact size. They are stand-alone units requiring only a standard 24 V or 48 V power supply. The built-in motor encoder allows closed-loop operation and slip/stall recovery features. An optional indexed knob provides convenient manual control for versatile operation even without a computer.

These stages connect to the RS-232 port or USB port of any computer, and they can be daisy-chained with any other Zaber products. The daisy-chain also shares power, making it possible for multiple X-Series products to share a single power supply. Convenient locking, 4-pin, M8 connectors on the unit allow for secure connection between units.

At only 21 mm high, these miniature stages are excellent for applications where a small profile is required. The X-LSM-E's innovative design allows speeds up to 104 mm/s and loads up to 25 kg. Like all of Zaber's products, the X-LSM-E Series is designed to be 'plug and play' and very easy to set up and operate. If you are considering a multi-axis system, in the XY configuration, these stages make excellent microscope stages. Adding an X-JOY3 joystick controller allows manual control of both X and Y or XYZ axes from a single interface as well as allowing microscope stage positions to be saved and recalled at the touch of a button.

For more information visit: <https://www.zaber.com/products/linear-stages/X-LSM-E>

X-LSM-E Series Part Numbering

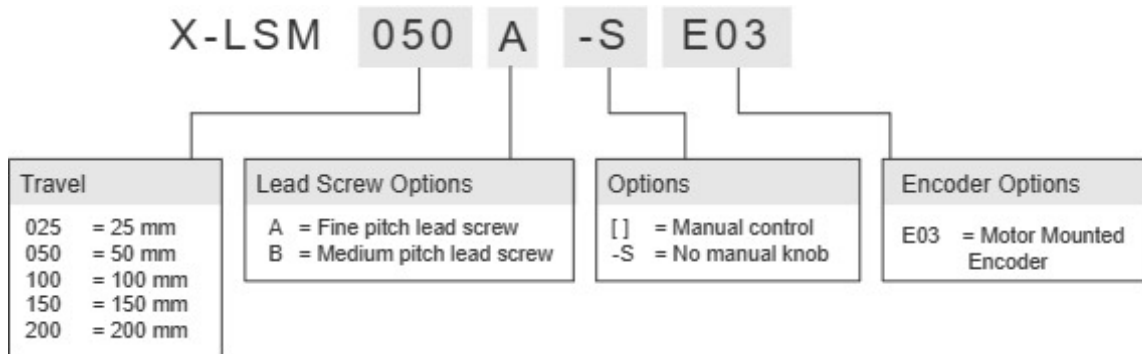

X-LSM150A-E03 Drawings

ZABER

X-LSM-E Miniature Motorized Linear Stage
 dimensions in mm

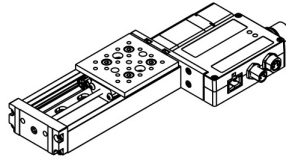

Model Number*	Travel	A **	B
X-LSM025	25.4	162.6	75.8
X-LSM050	50.8	188.0	101.2
X-LSM100	101.6	238.8	152.0
X-LSM150	152.4	289.6	202.8
X-LSM200	203.2	340.4	253.6

*See product page for complete list of available models at www.zaber.com

**Subtract 13.1 mm knob length from 'A' for -S versions without manual control

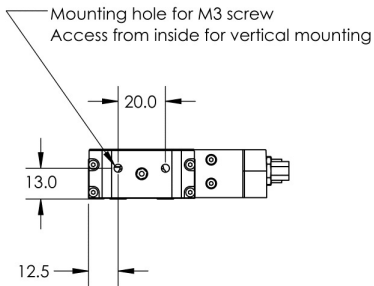
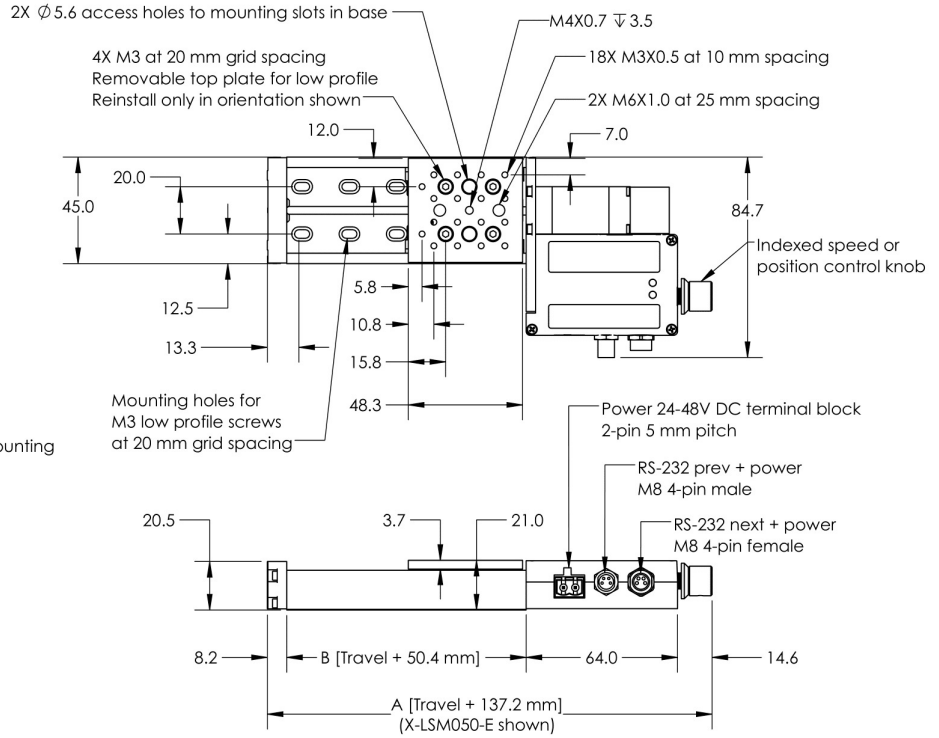

DWG 3429 R01

X-LSM150A-E03 Specifications

Specification	Value	Alternate Unit
Microstep Size (Default Resolution)	0.047625 μm	
Built-in Controller	Yes	
Travel Range	152.4 mm	6.000"
Accuracy (unidirectional)	50 μm	0.001968"
Repeatability	< 3 μm	< 0.000118"
Backlash	< 12 μm	< 0.000472"
Maximum Speed	26 mm/s	1.024"/s
Minimum Speed	0.000029 mm/s	0.000001"/s
Speed Resolution	0.000029 mm/s	0.000001"/s
Encoder Resolution	200 CPR	800 states/rev
Encoder Type	Rotary quadrature encoder	
Peak Thrust	55 N	12.3 lb
Maximum Continuous Thrust	25 N	5.6 lb
Communication Interface	RS-232	
Communication Protocol	Zaber ASCII (Default), Zaber Binary	
Data Cable Connection	Locking 4-pin M8	
Maximum Centered Load	250 N	56.1 lb
Maximum Cantilever Load	10 N-m	7.4 ft-lb
Guide Type	Recirculating ball bearing	
Vertical Runout	< 25 μm	< 0.000984"
Horizontal Runout	< 23 μm	< 0.000906"
Pitch	0.04°	0.698 mrad
Roll	0.05°	0.873 mrad
Yaw	0.05°	0.873 mrad
Stiffness in Pitch	150 N-m/°	116 $\mu\text{rad/N-m}$
Stiffness in Roll	150 N-m/°	116 $\mu\text{rad/N-m}$
Stiffness in Yaw	150 N-m/°	116 $\mu\text{rad/N-m}$
Power Supply	24-48 VDC	
Power Plug	2-pin Screw Terminal	
Maximum Current Draw	350 mA	

Specification	Value	Alternate Unit
Linear Motion Per Motor Rev	0.6096 mm	0.024"
Motor Steps Per Rev	200	
Motor Type	Stepper (2 phase)	
Motor Rated Current	600 mA/phase	
Inductance	3.5 mH/phase	
Default Resolution	1/64 of a step	
Mechanical Drive System	Precision lead screw	
Limit or Home Sensing	Magnetic hall sensor	
Manual Control	Yes	
Axes of Motion	1	
LED Indicators	Yes	
Mounting Interface	M3 and M6 threaded holes and M4 threaded centre hole	
Stage Parallelism	< 25 µm	< 0.000984"
Operating Temperature Range	0 to 50 °C	
RoHS Compliant	Yes	
CE Compliant	Yes	
Vacuum Compatible	No	
Weight	0.43 kg	0.948 lb

X-LSM-E Series Charts

Thrust Speed Performance

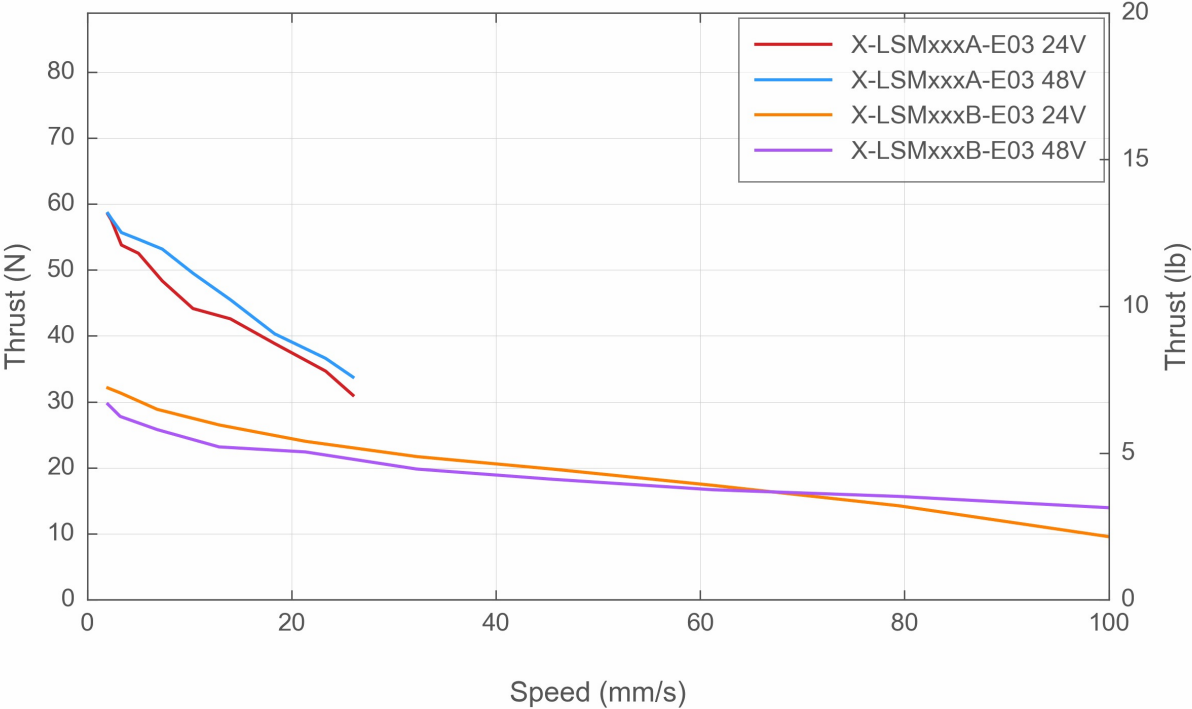

Thrust Speed Performance

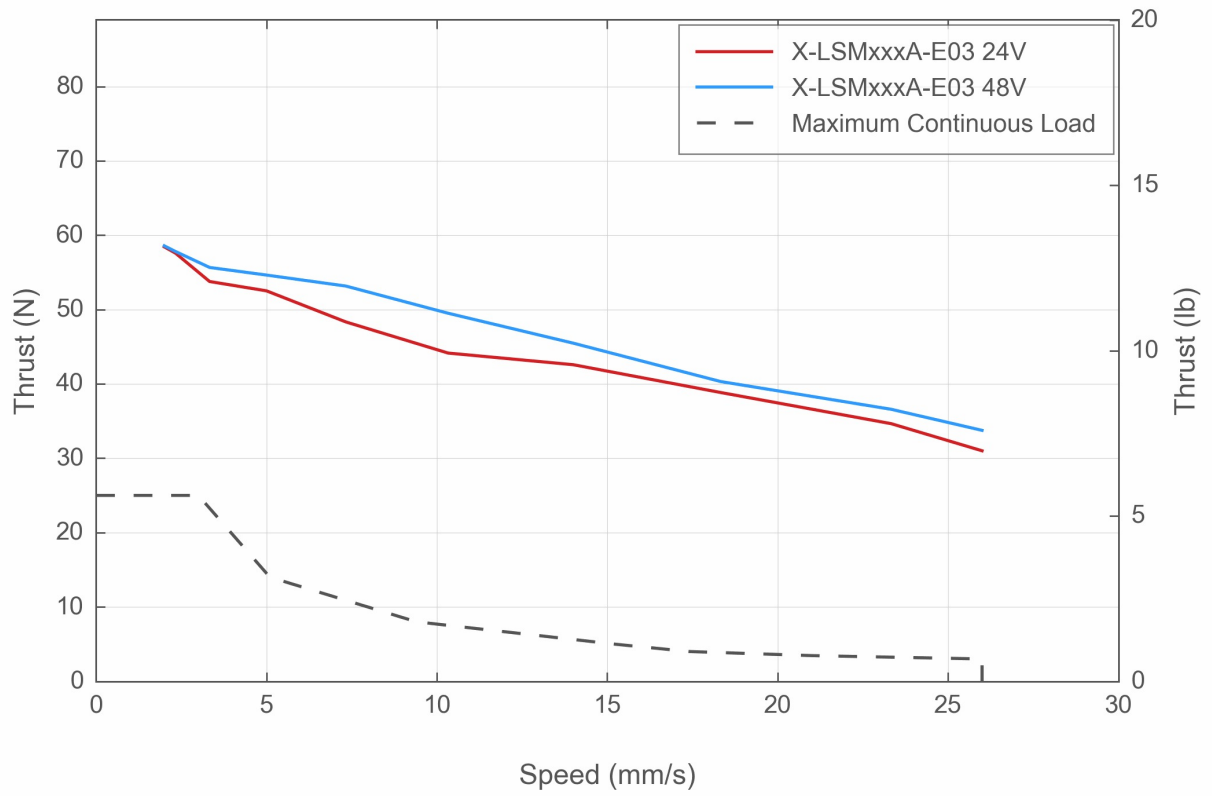

Thrust Speed Performance

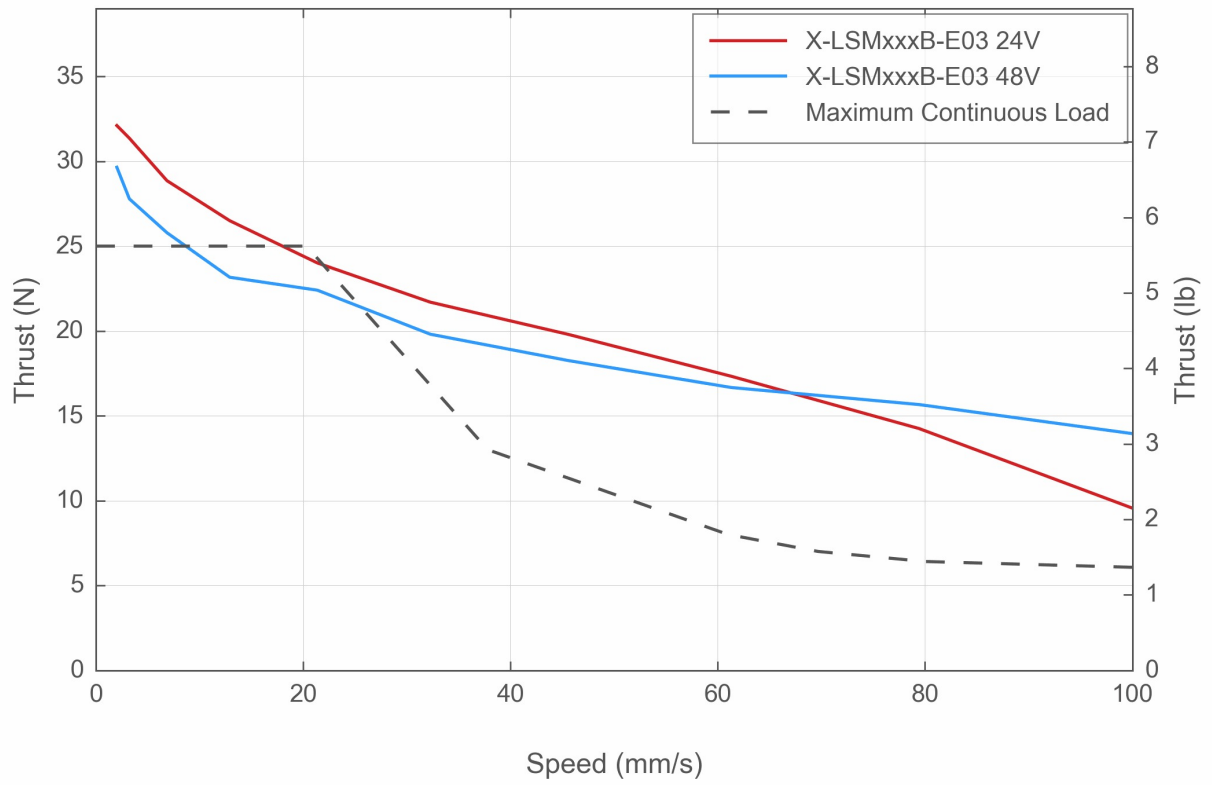

Typical Accuracy

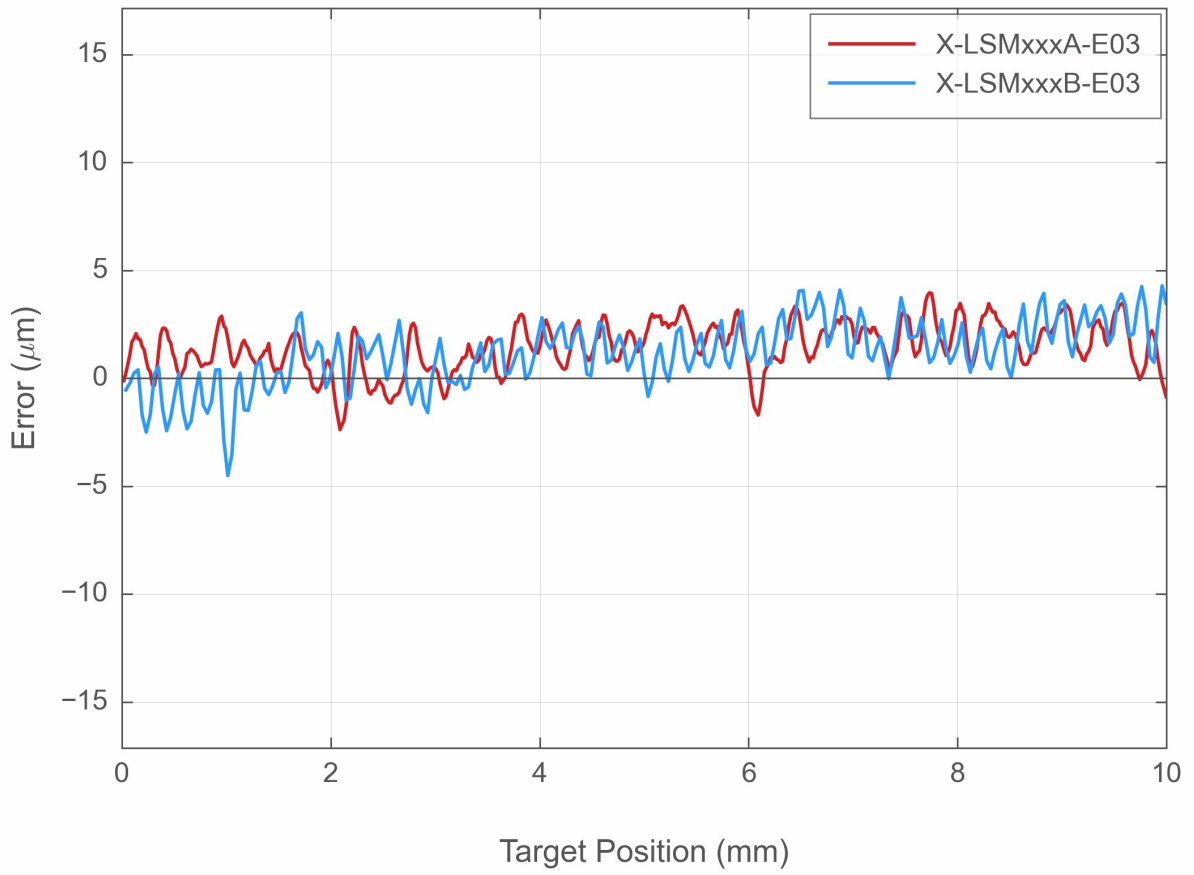

Typical Microstepping Accuracy

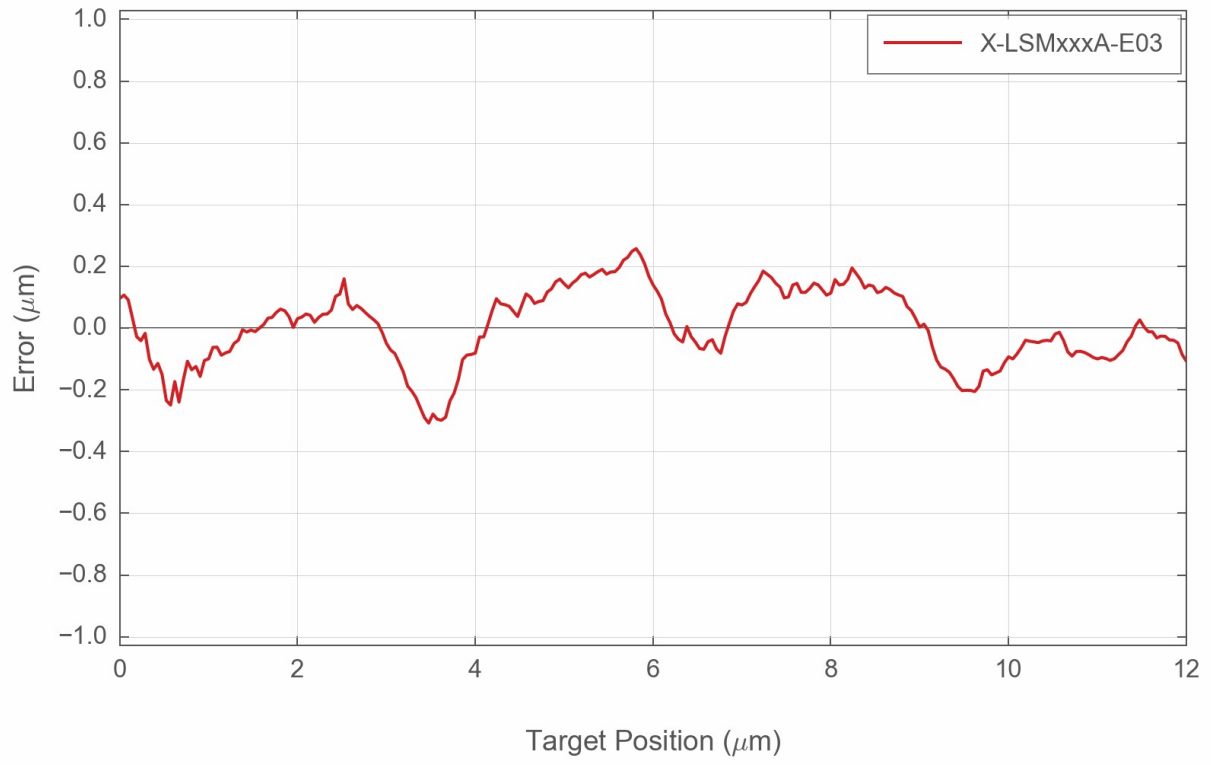

Typical Microstepping Accuracy

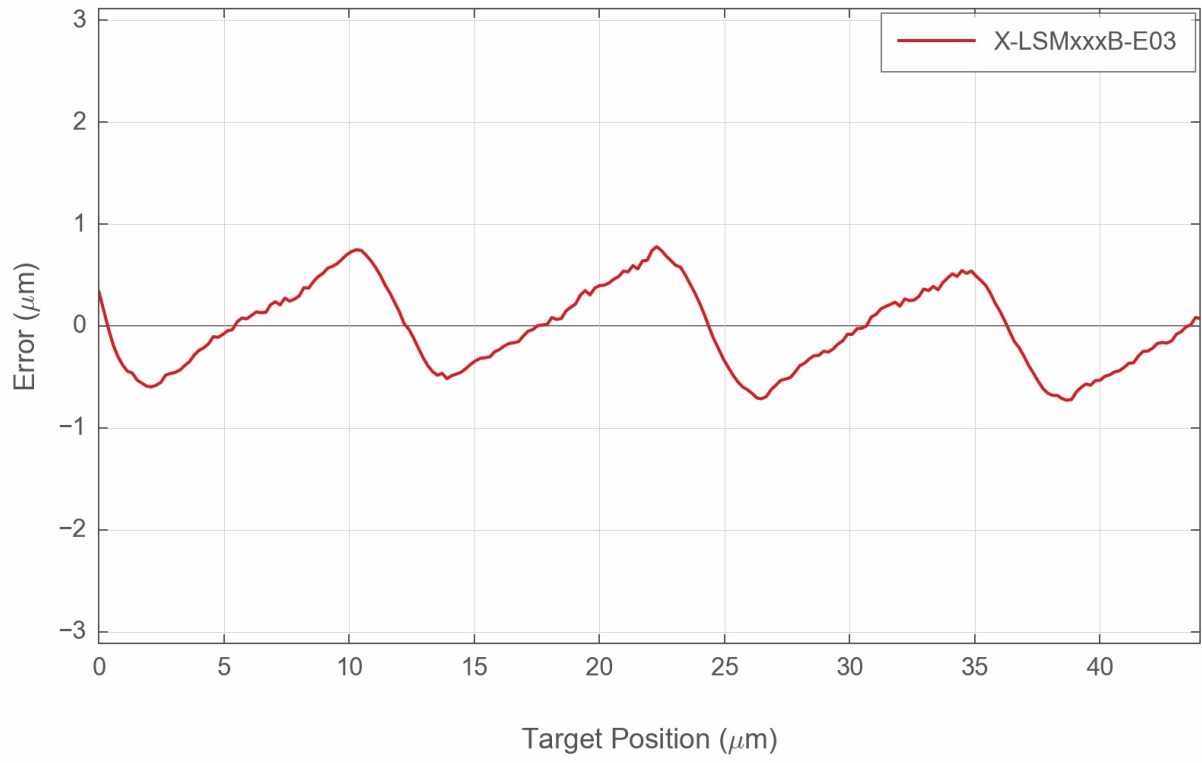

LSM Linear Bearing Lifetime

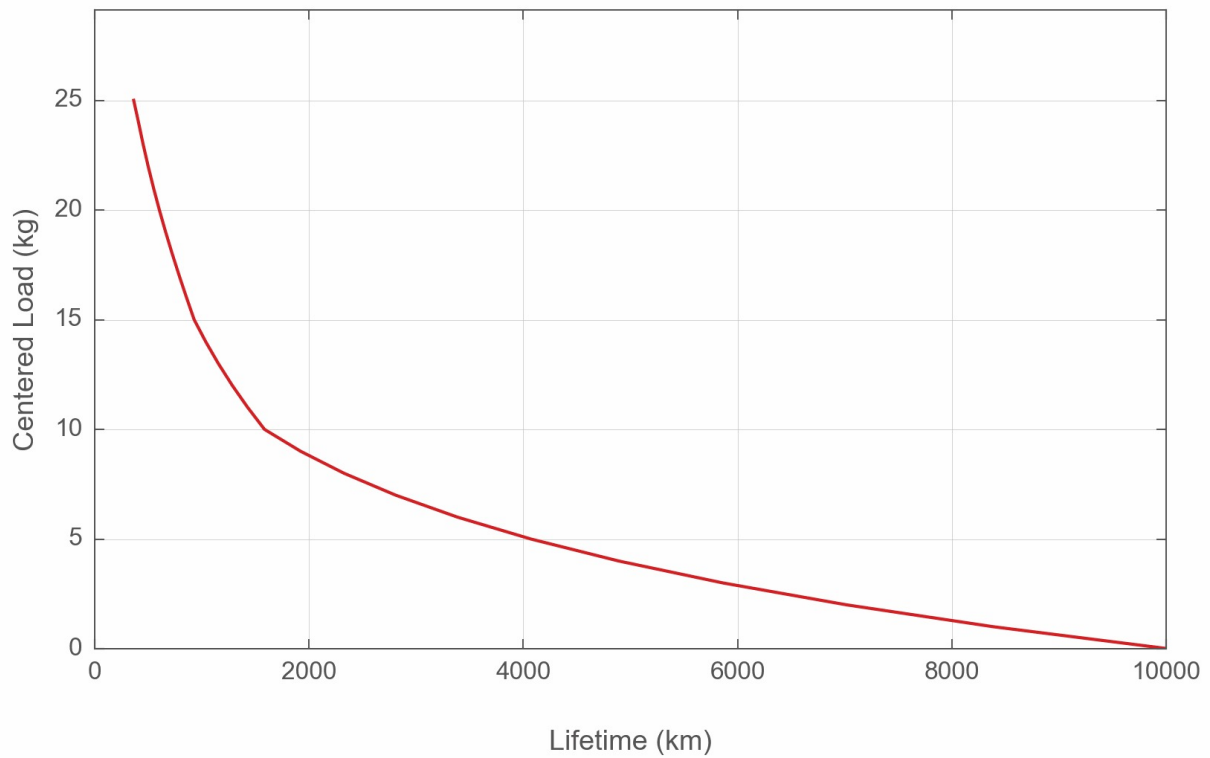

Contact

Email: contact@zaber.com

Phone (toll free Canada/USA): 1-888-276-8033

Phone (direct): 1-604-569-3780

Fax: 1-604-648-8033

Zaber Technologies Inc.

#2 - 605 West Kent Ave. N.

Vancouver, British Columbia

Canada, V6P 6T7

<https://www.zaber.com>